

# SICILIA 40



6x140 mm



2/20

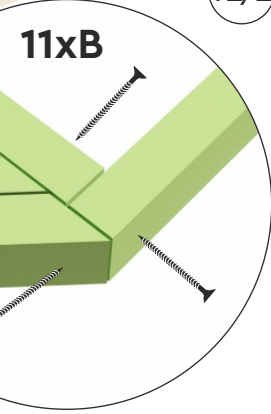
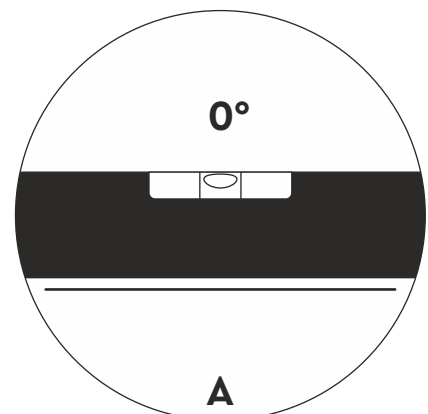
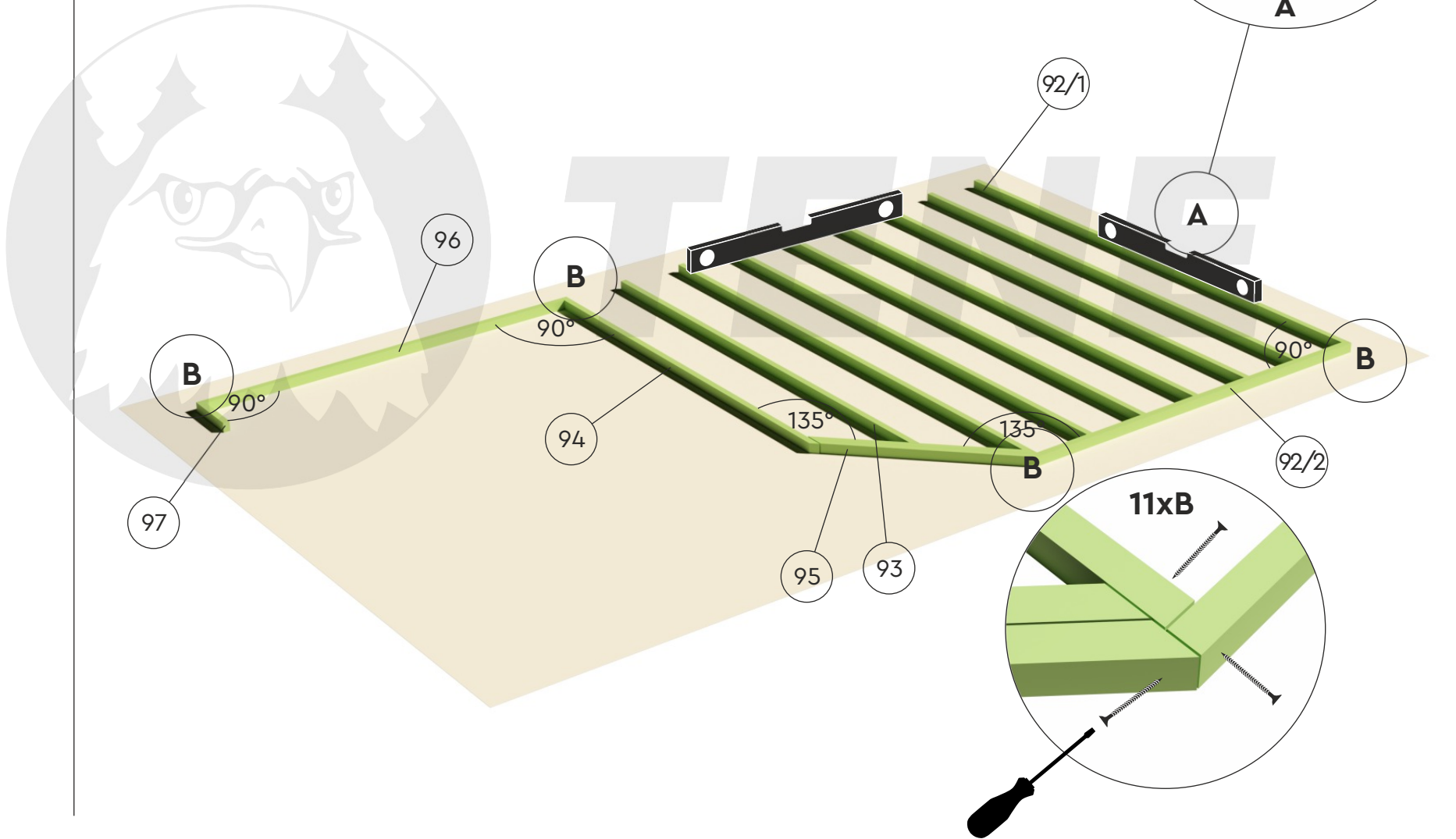

# SICILIA 40

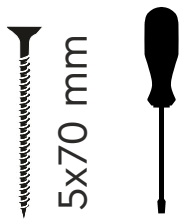
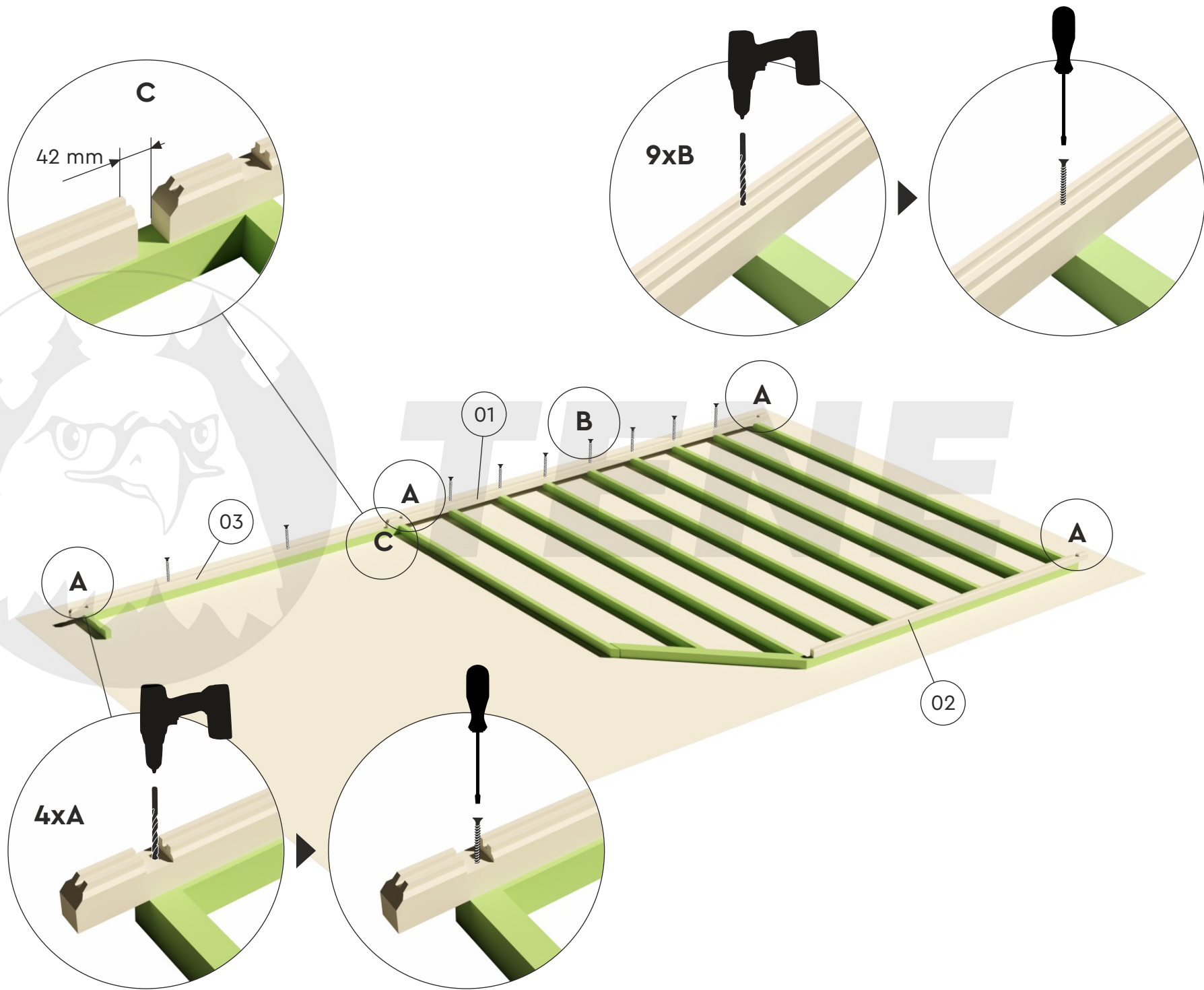

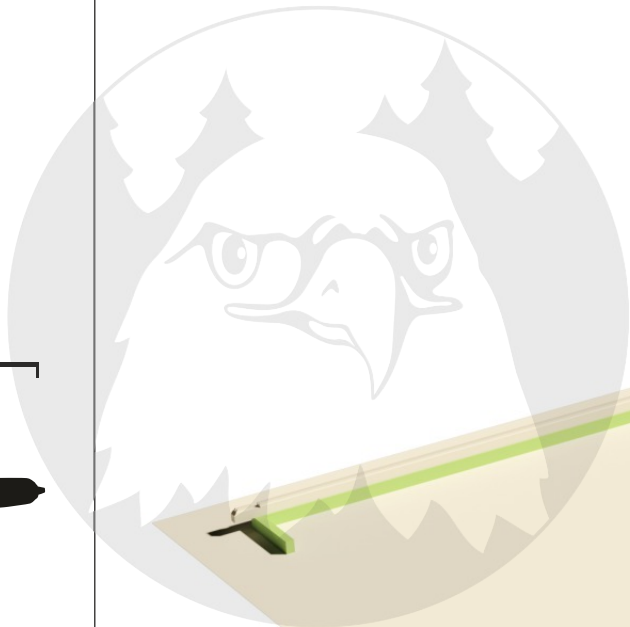
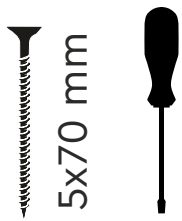

TECHNIFE

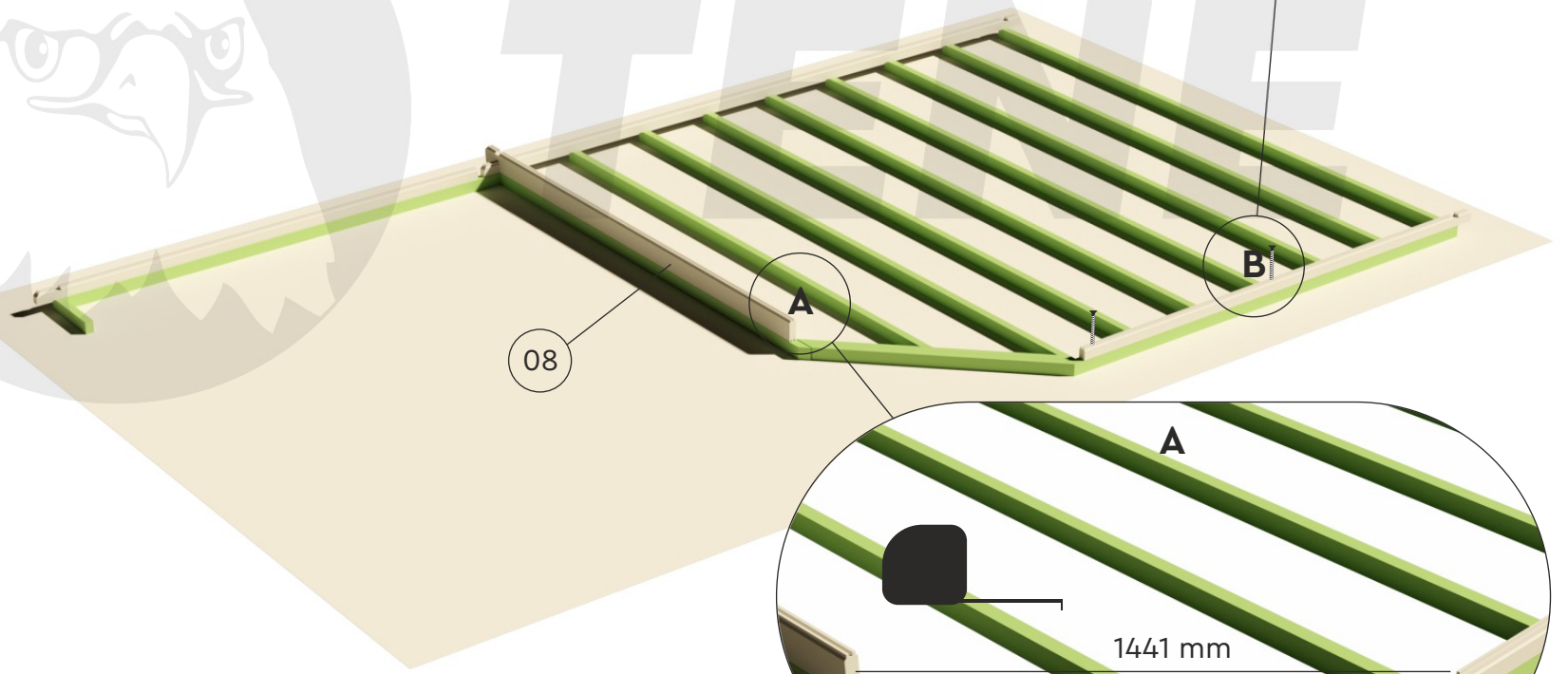
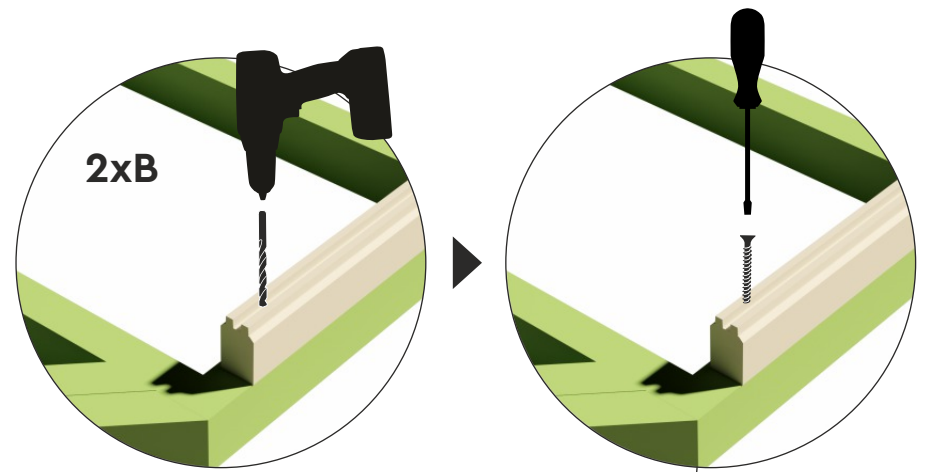

# SICILIA 40

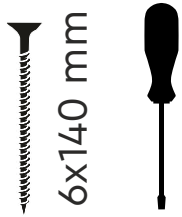
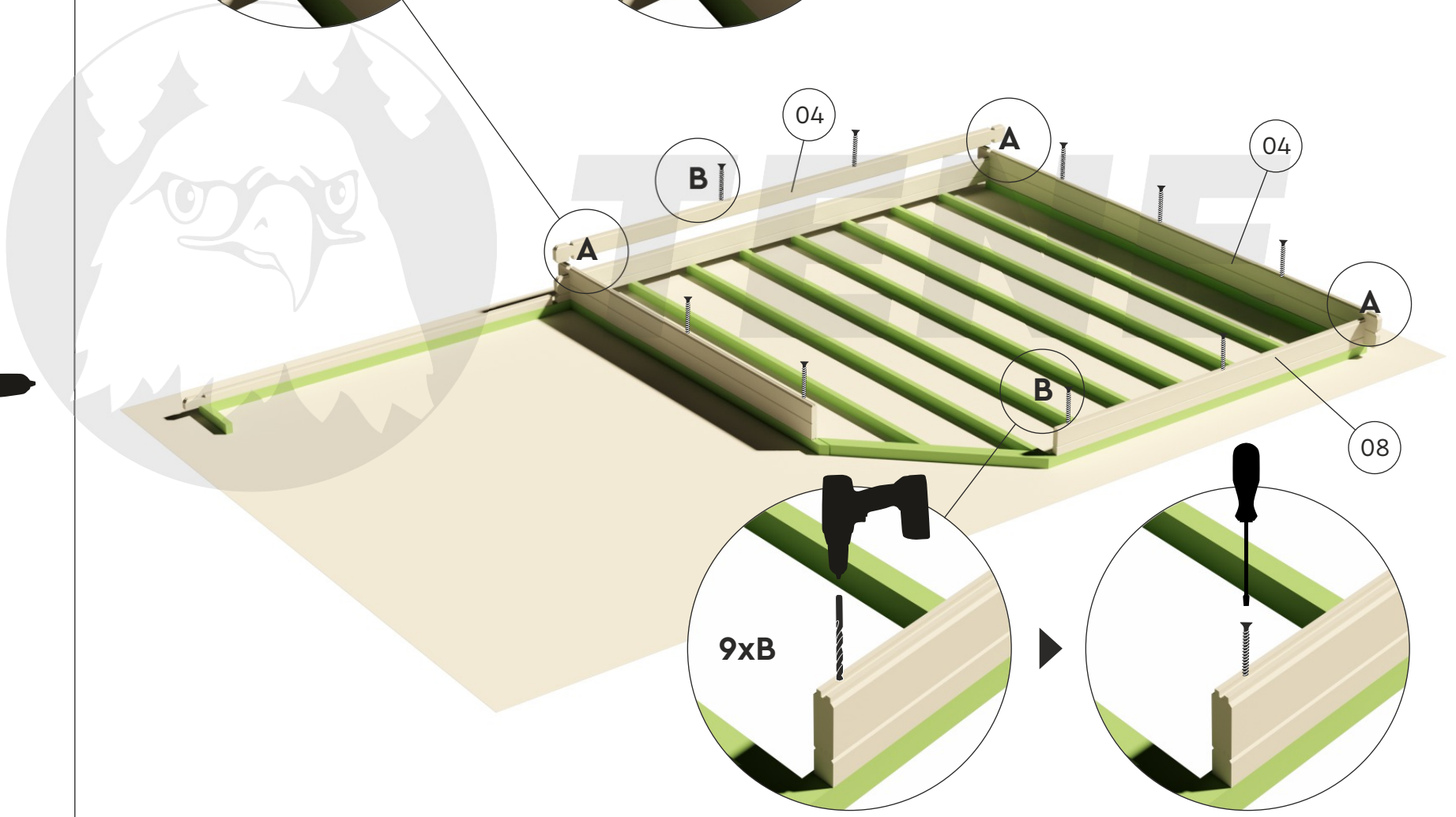
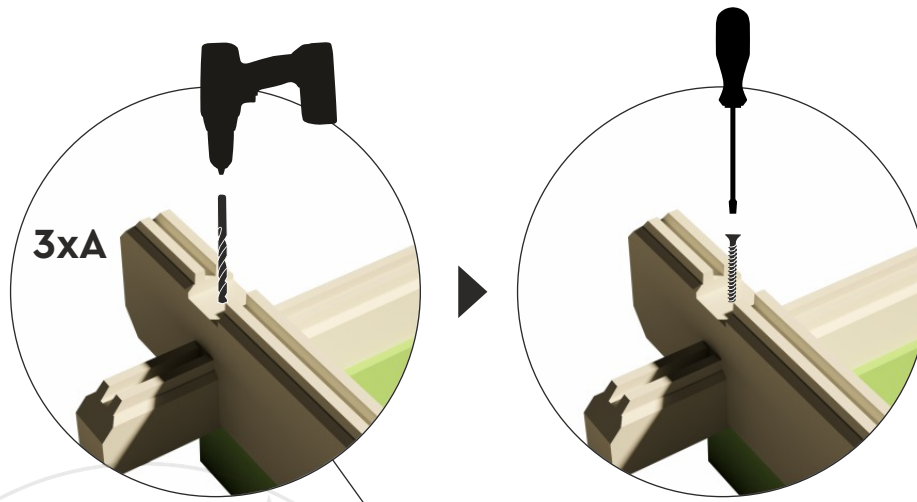

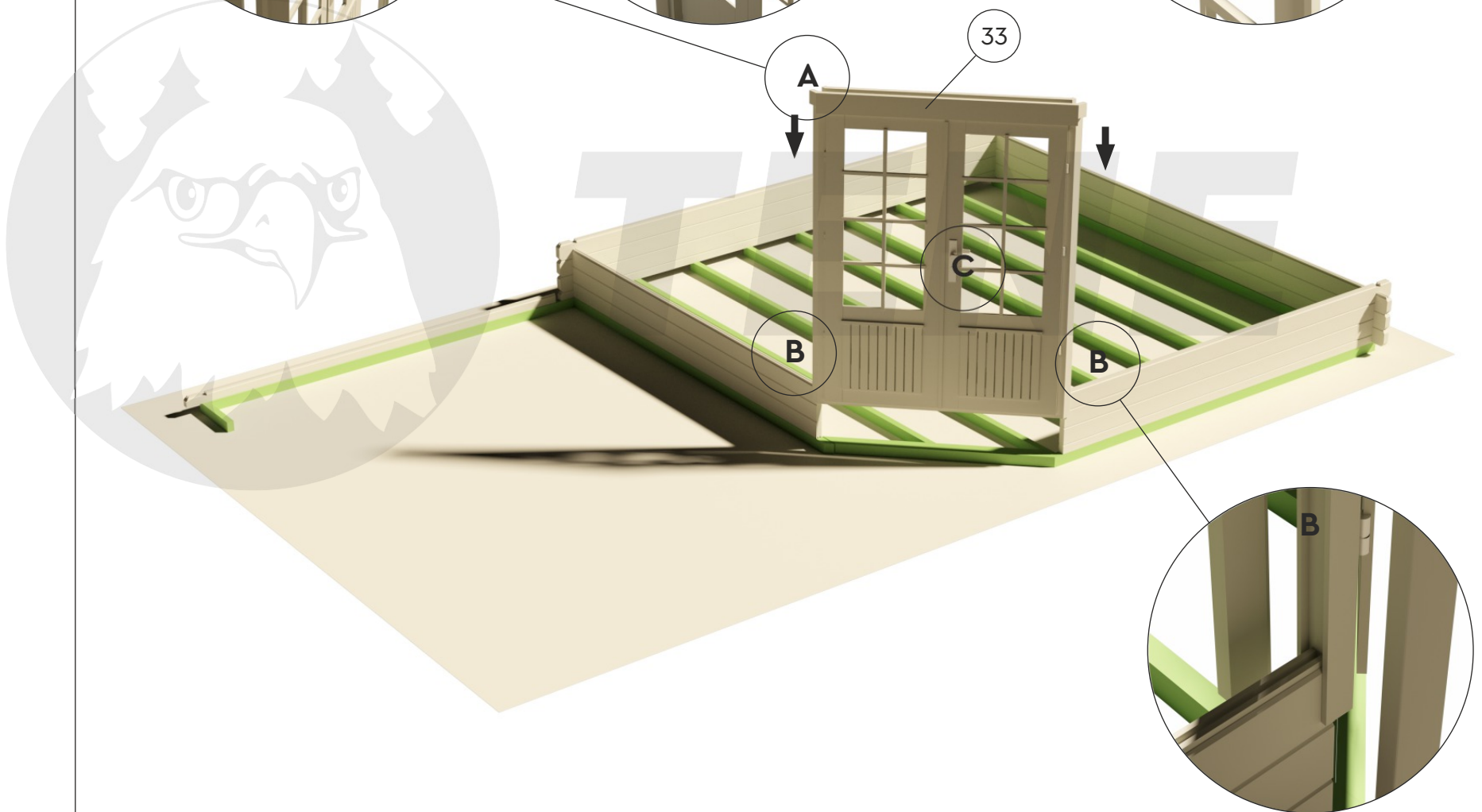
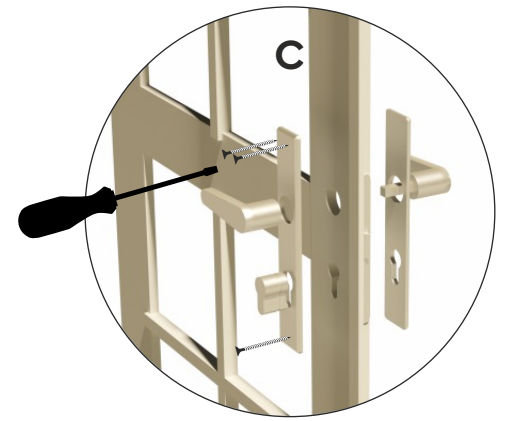
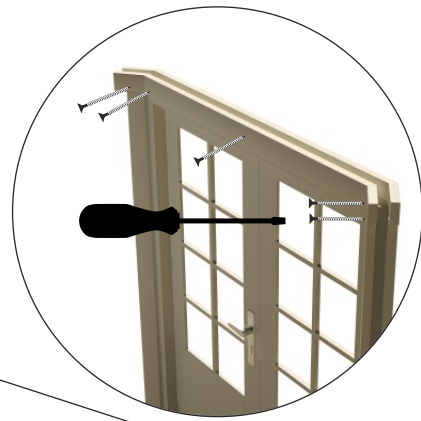
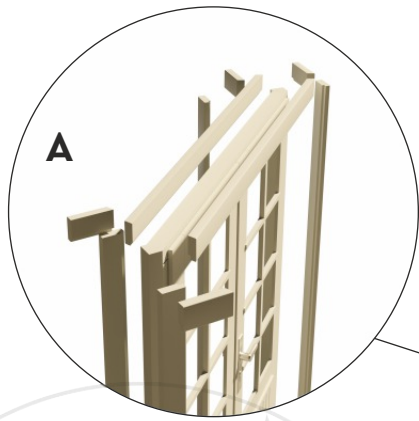

4x40 mm



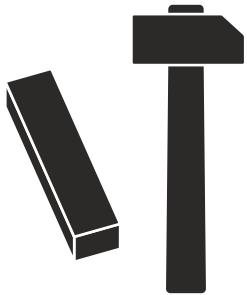
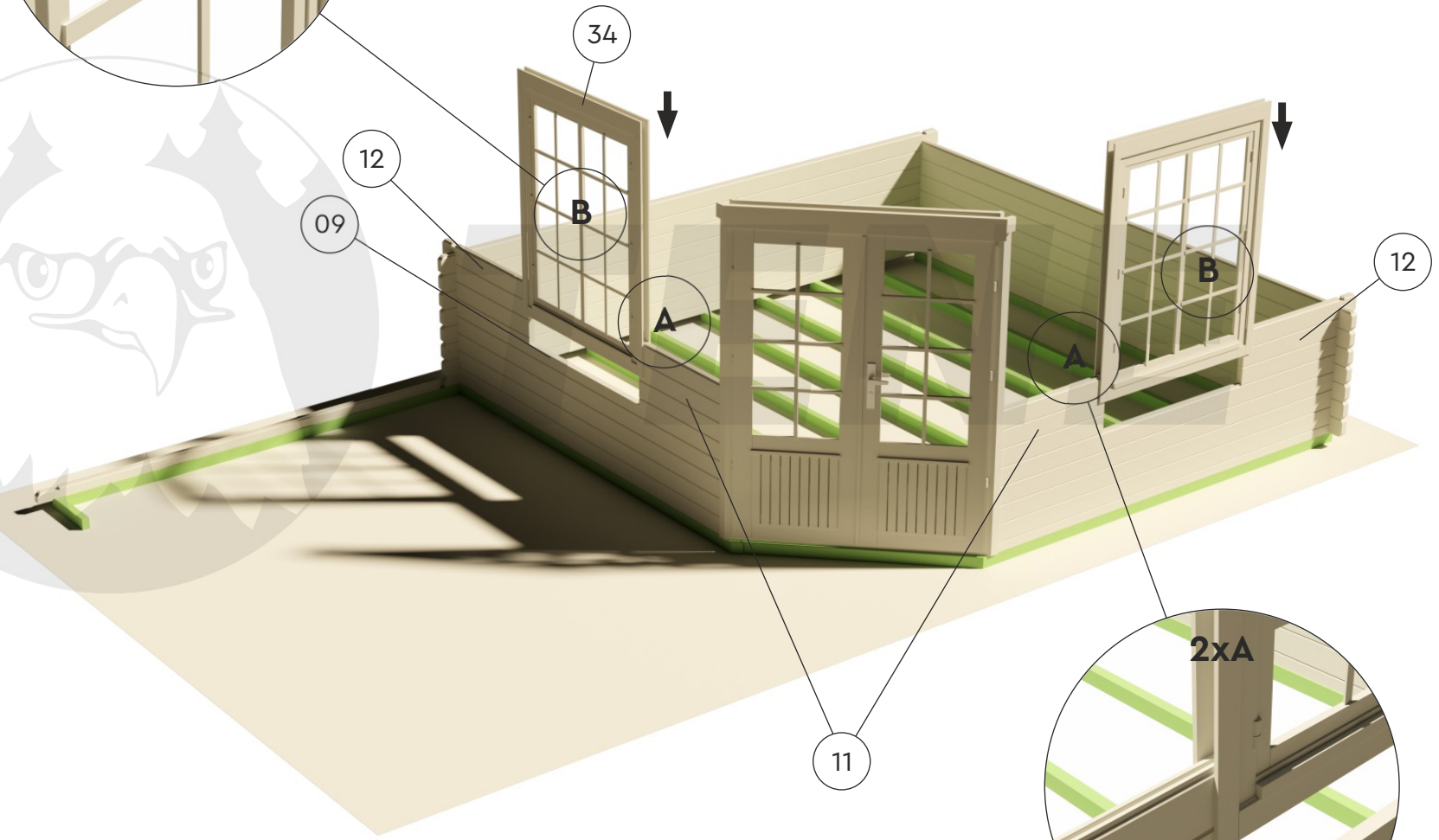
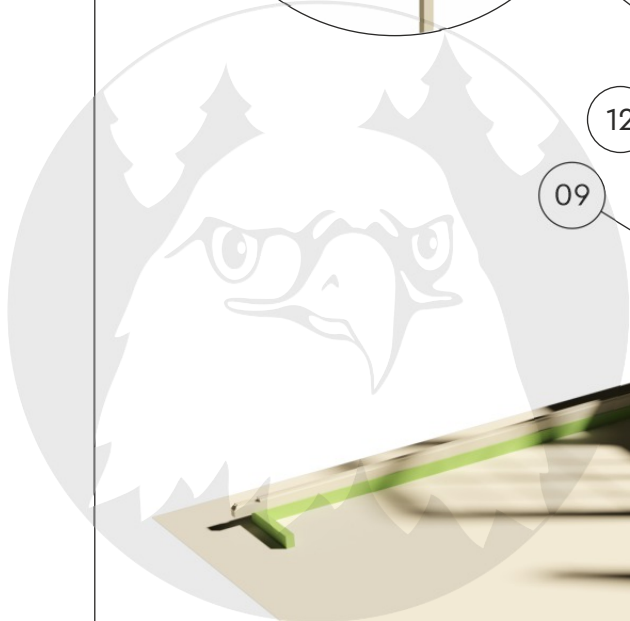
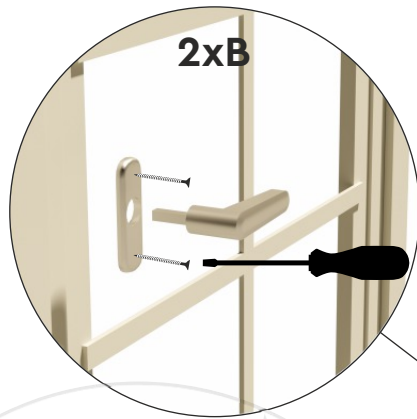

# SICILIA 40

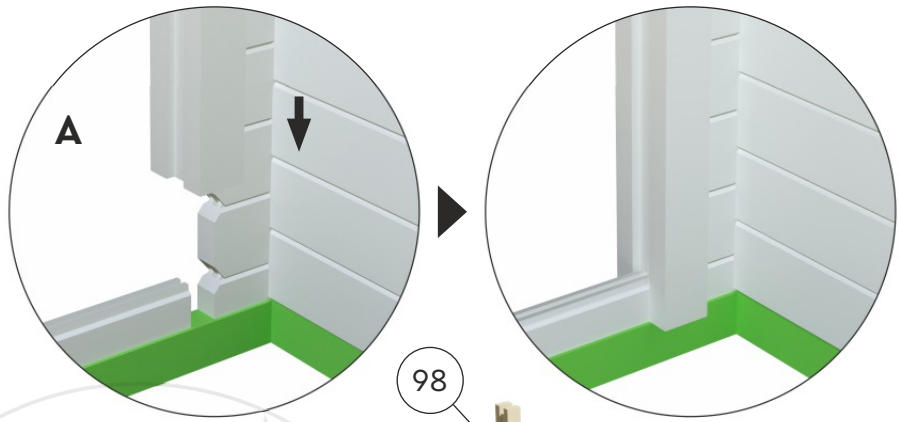

98

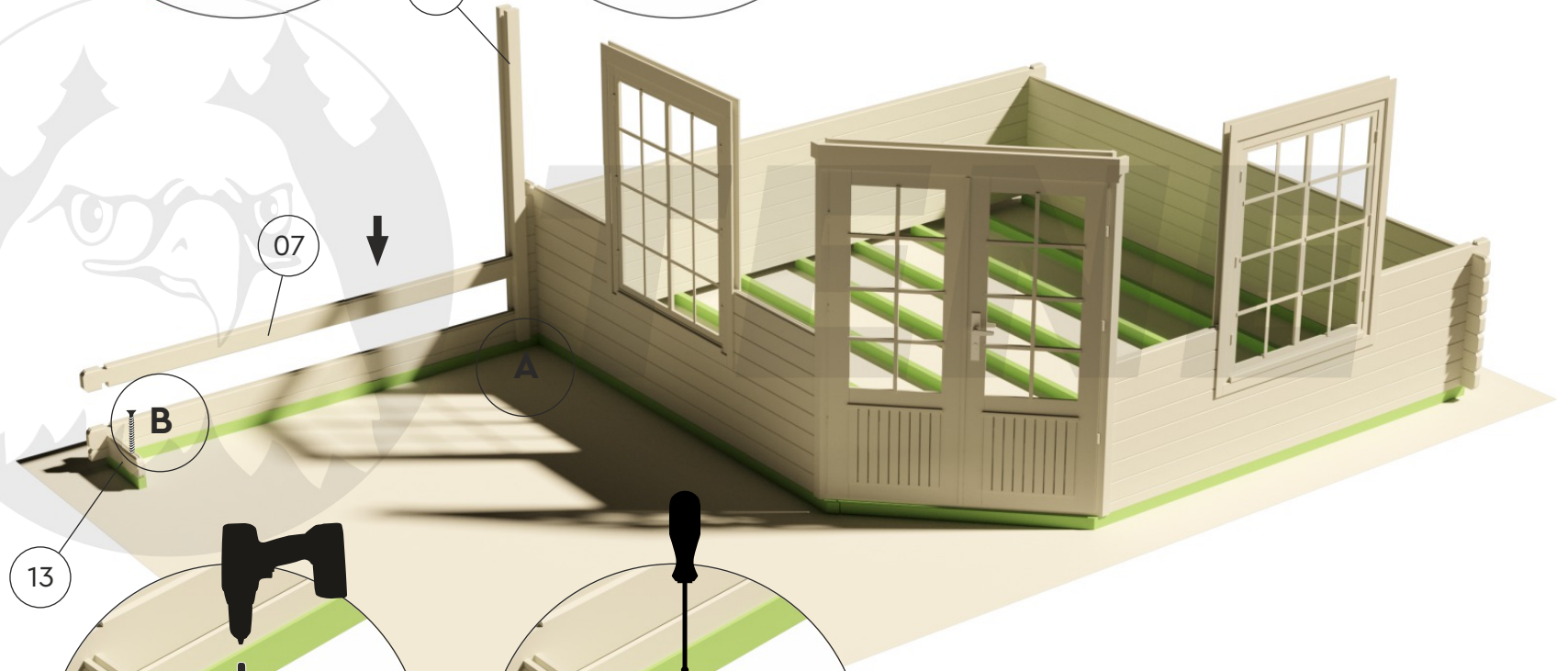

07

B

A

13

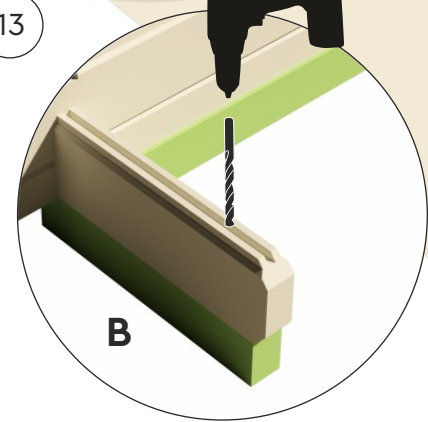
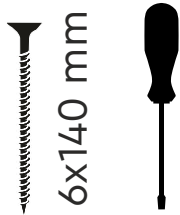

B

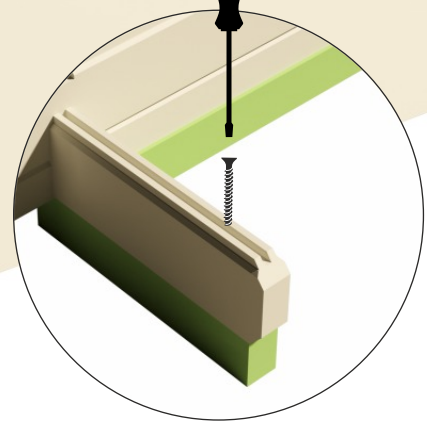



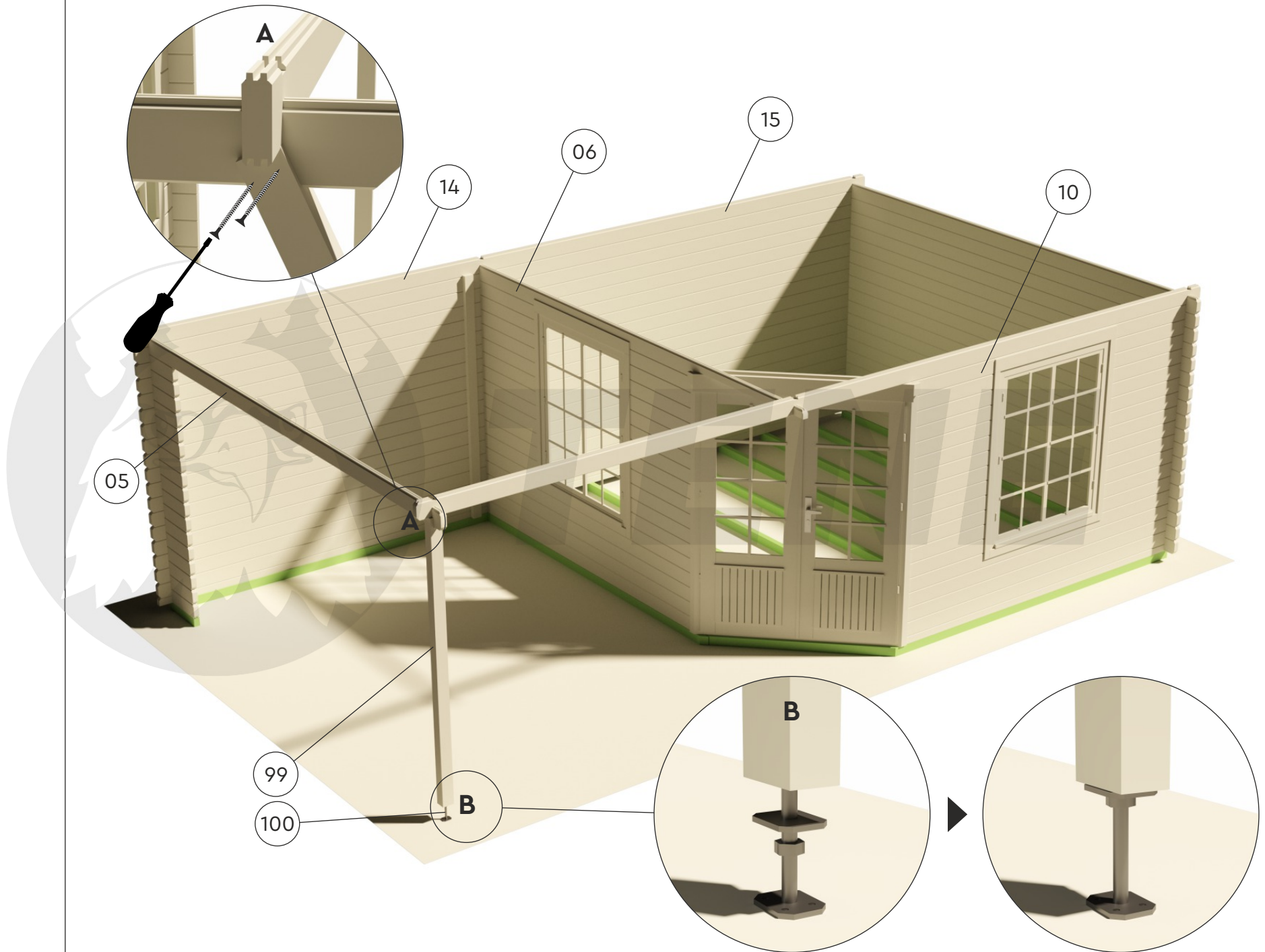







4x40 mm



# SICILIA 40

-  Ø 5 mm
-  Ø 4 mm
- 
-  6x140 mm
-  4x50 mm
- 

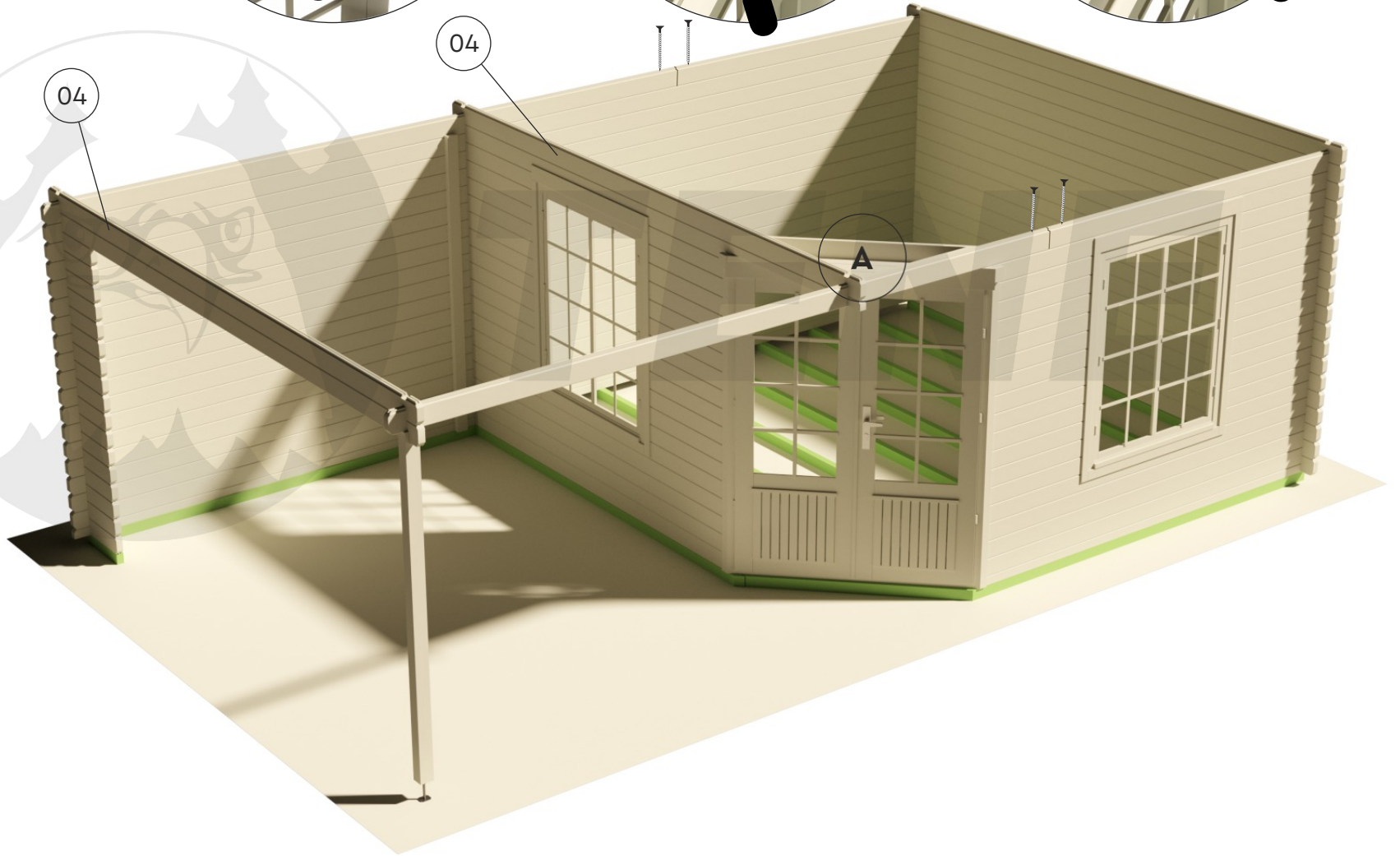
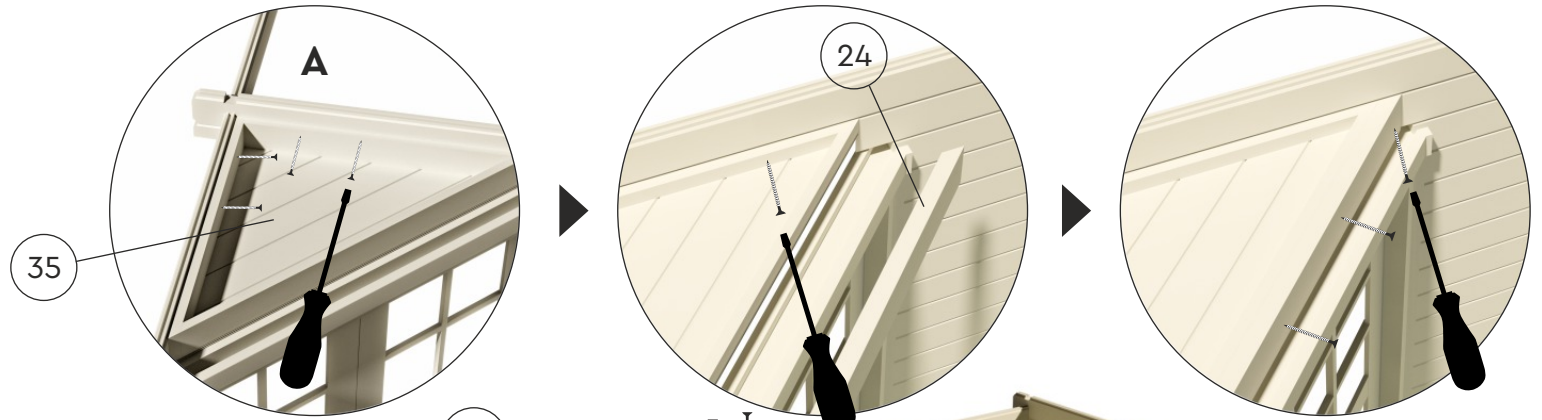

# SICILIA 40

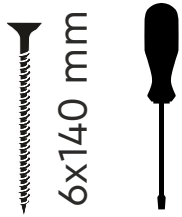
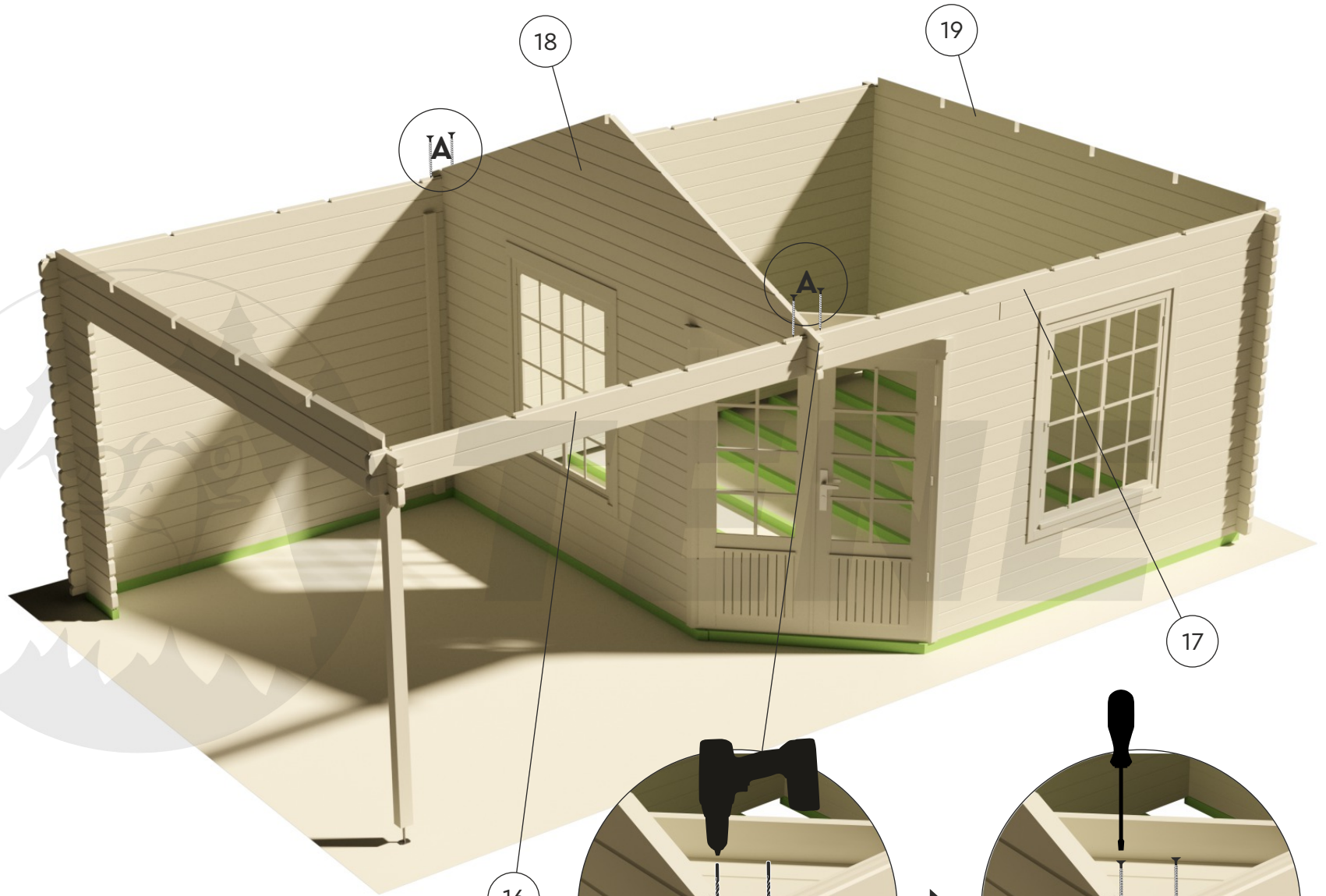

16

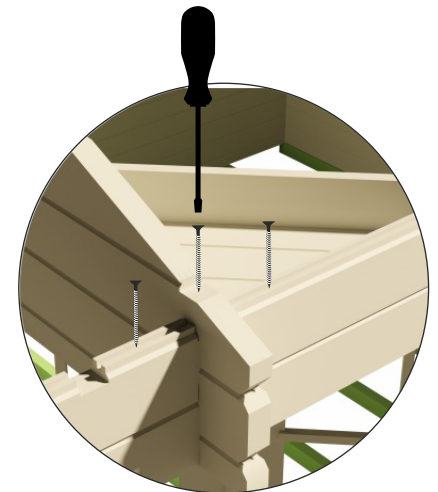
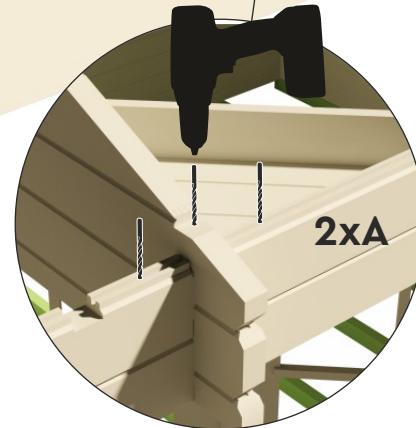

# SICILIA 40

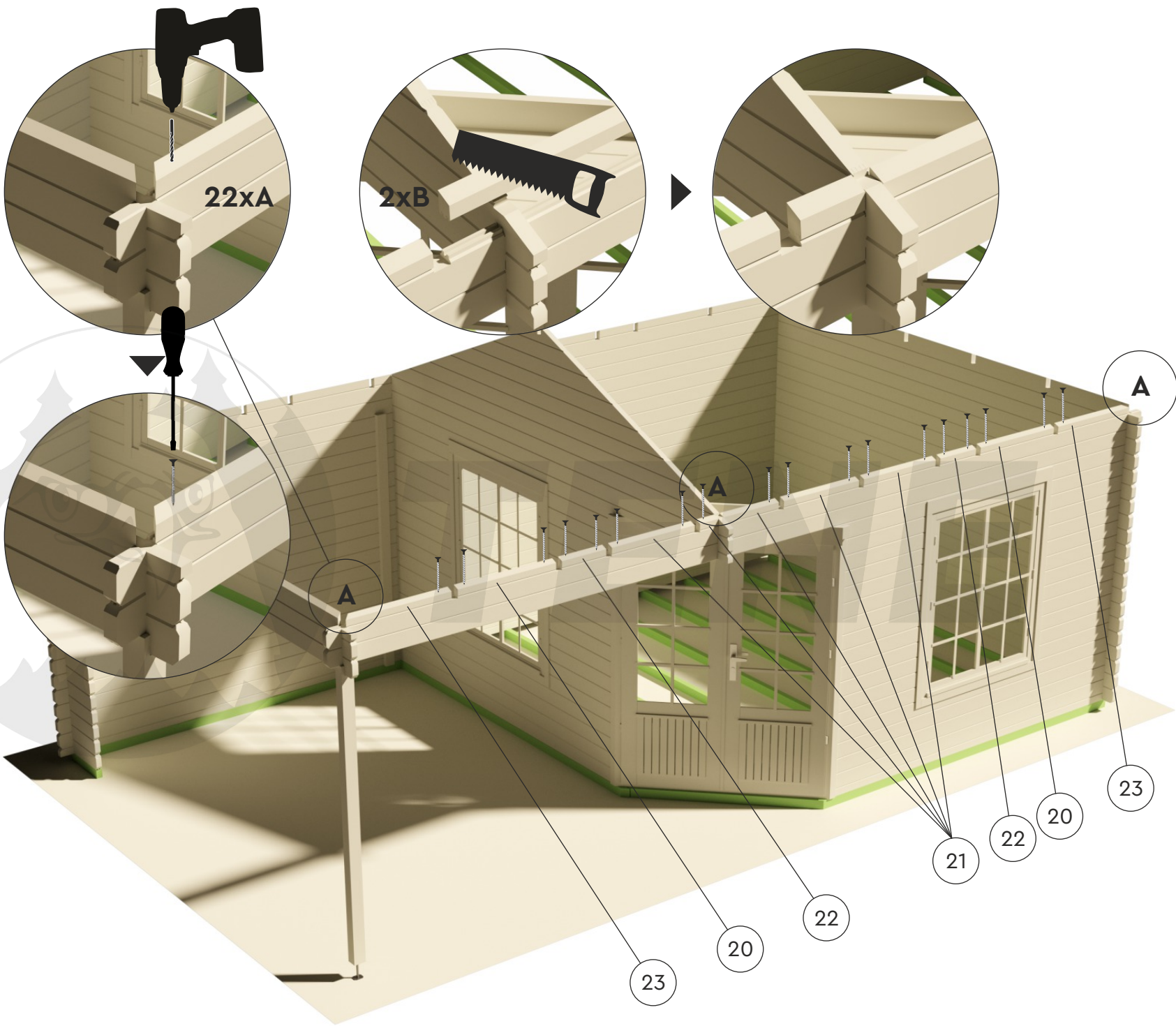

∅ 4 mm



5x70 mm



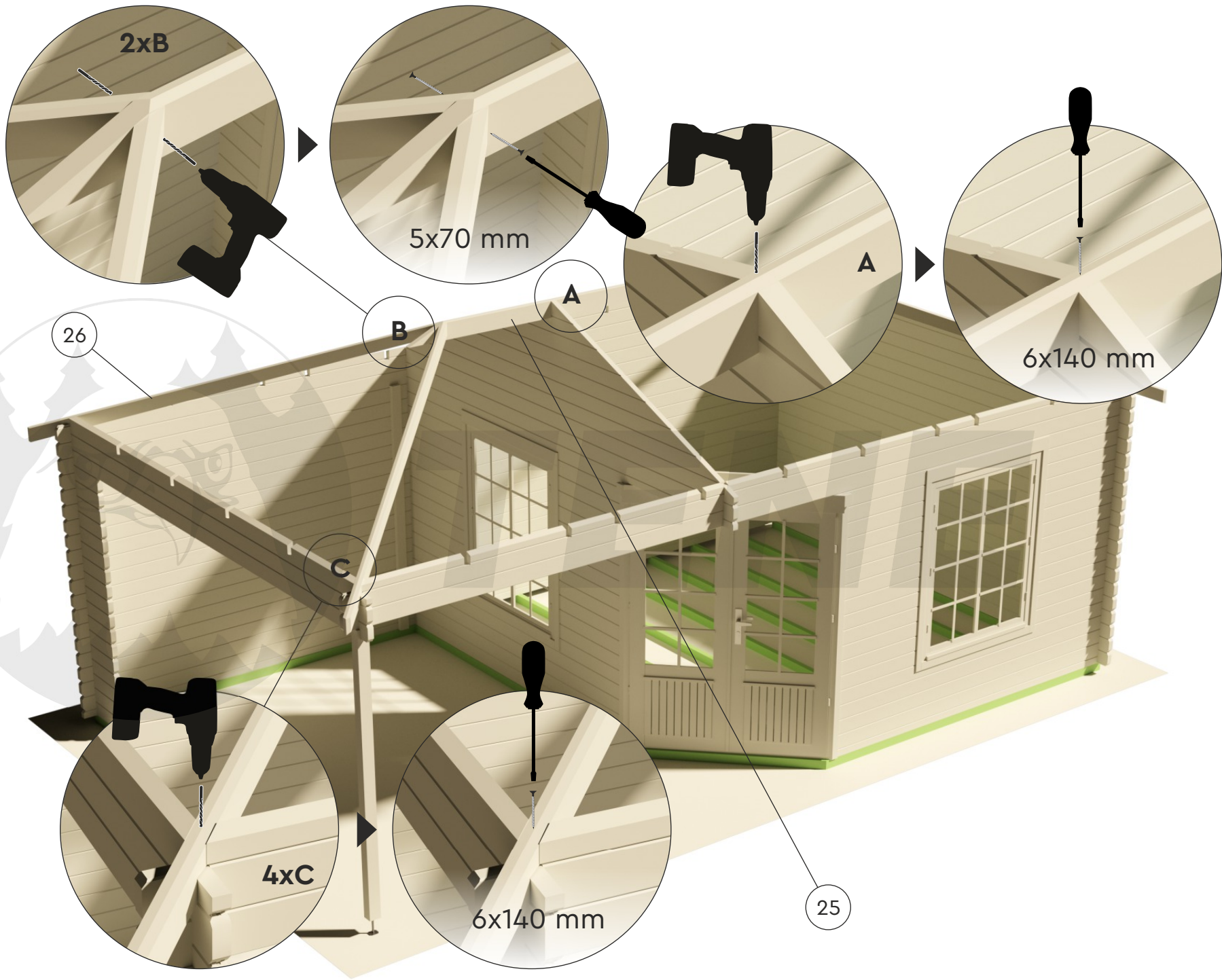

# SICILIA 40

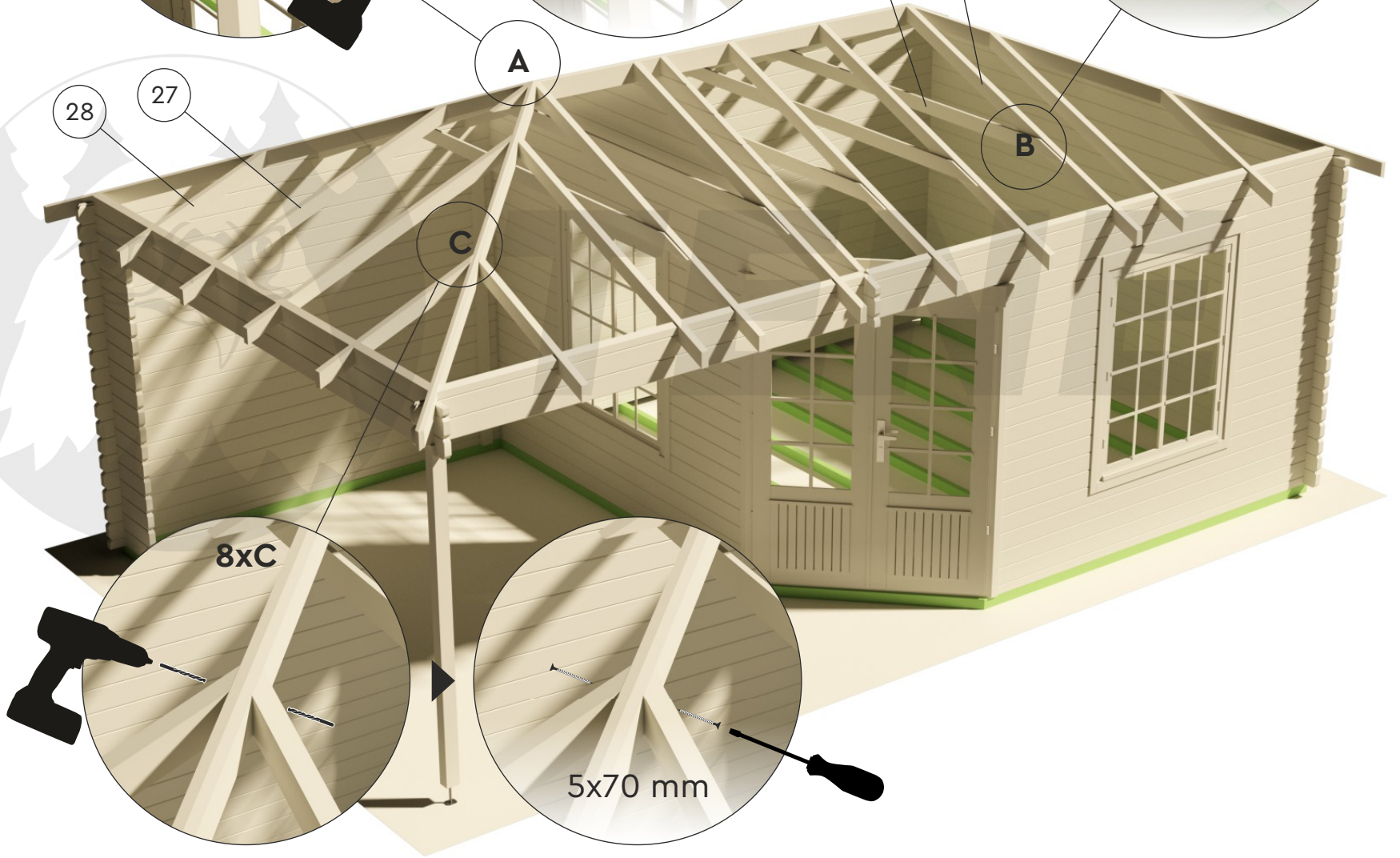
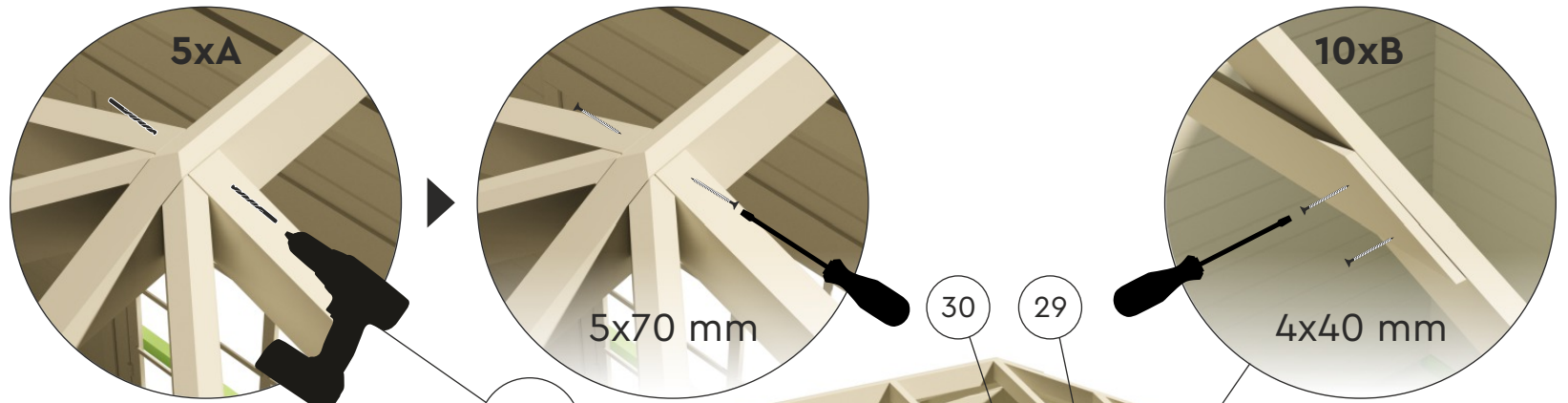

# SICILIA 40

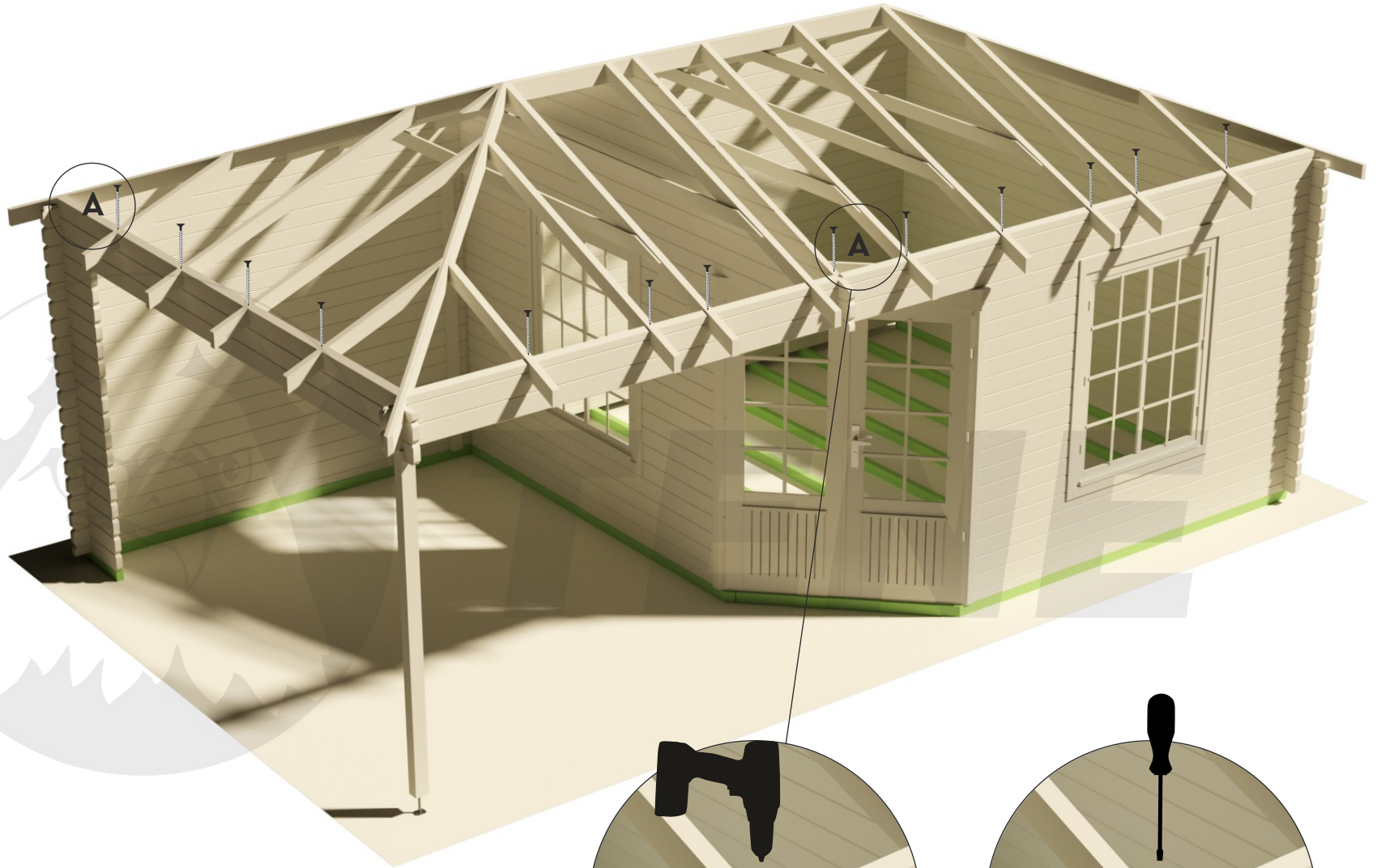

Ø 5 mm

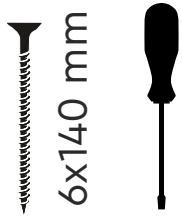

6x140 mm



26xA

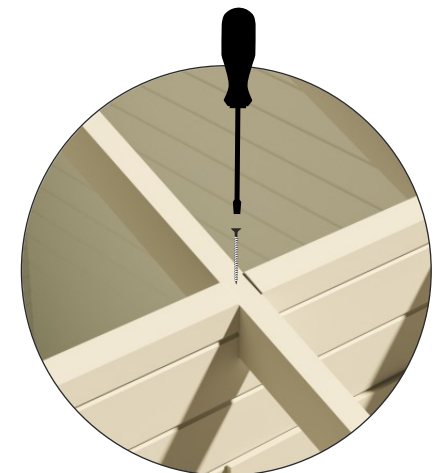

# SICILIA 40

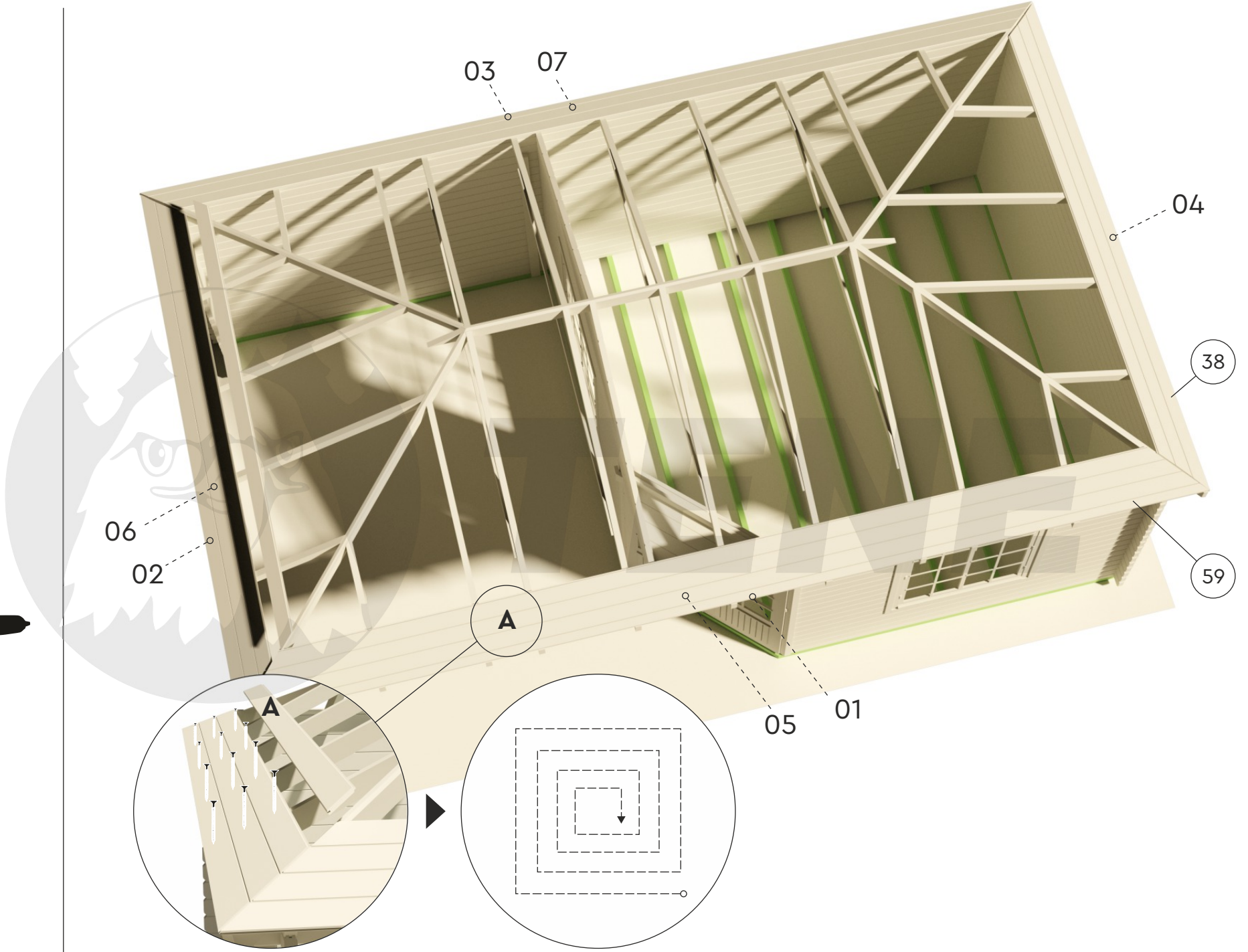

Ø 3 mm

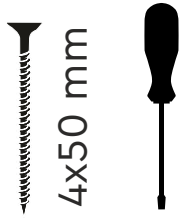

4x50 mm



# SICILIA 40

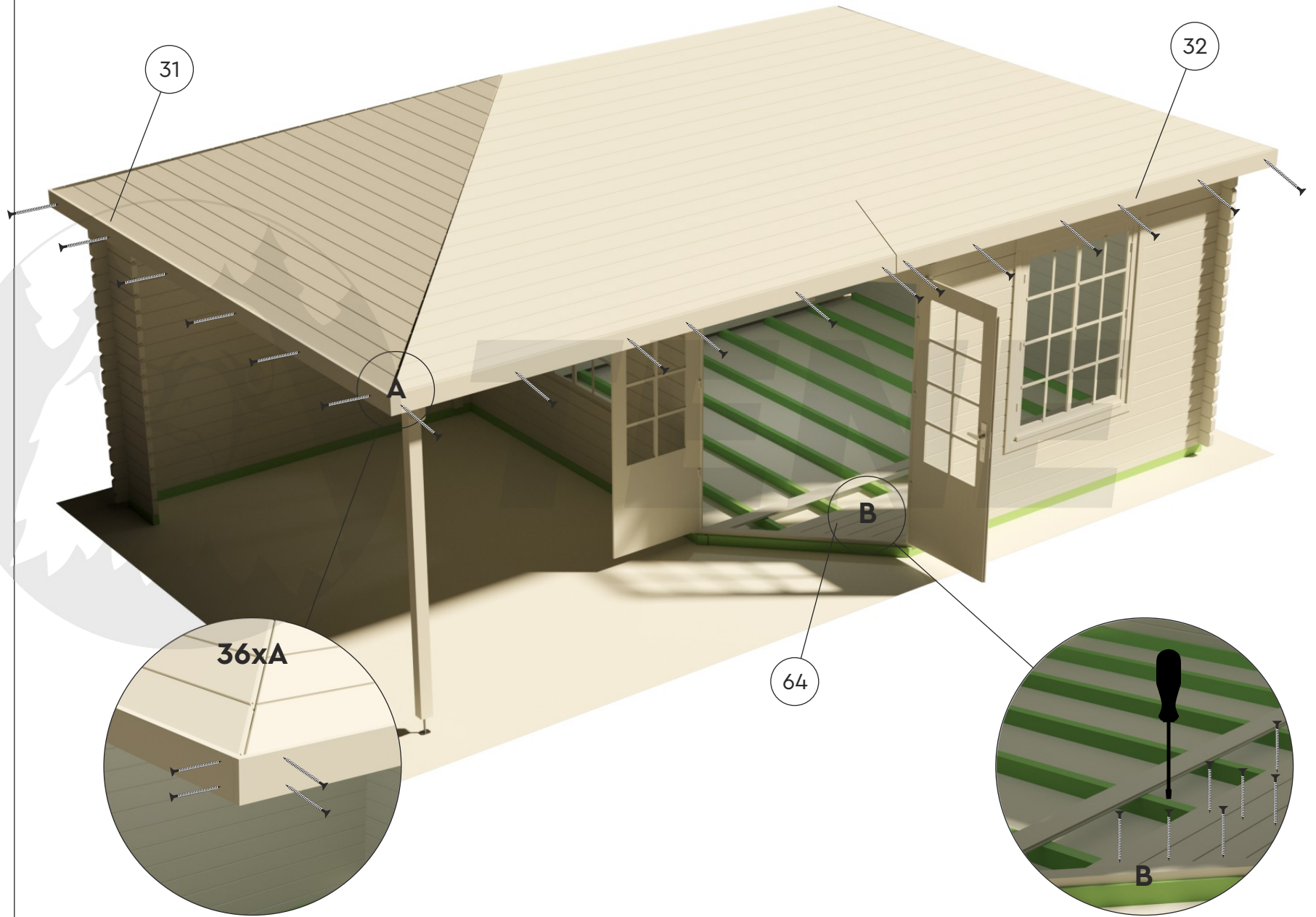
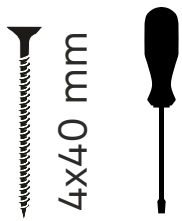

# SICILIA 40

